

Data Sheet



Article number: 021816011085

Description: Clamp with bracket and rubber
SPGU 6011. 85/30 SK

Measures

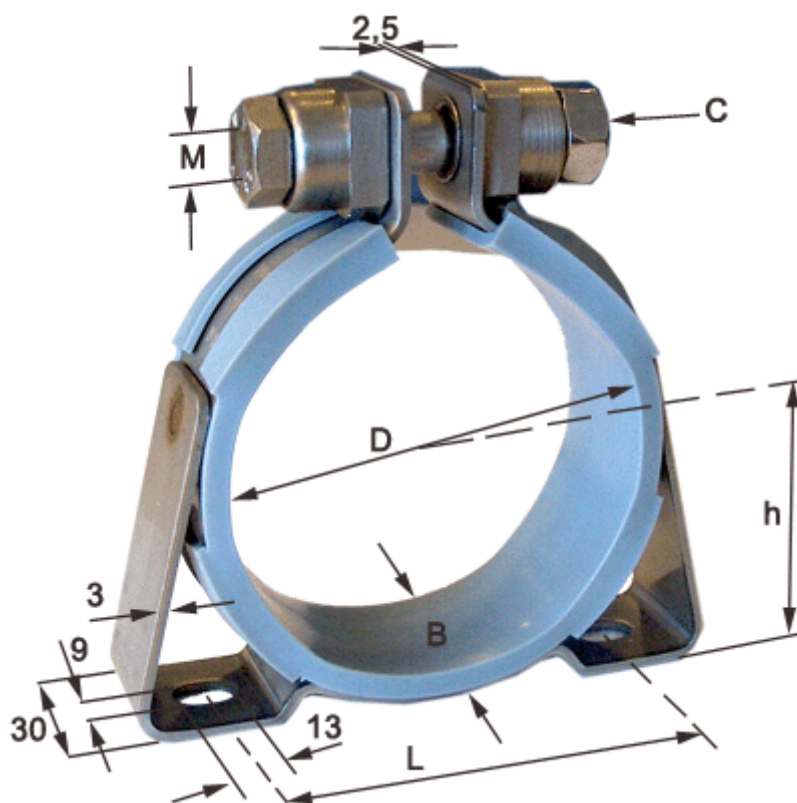

C (screw type) = SK hexagon screw

Diameter D = 85

h = 51

L = 90

Width B = 30